

SALUS SERIES



IGIENICO, STABILE, ROBUSTO E FLESSIBILE

- Modulare = infinite combinazioni possibili
- Altezze personalizzabili ogni 120 mm
- Compatibile con i contenitori ISO 60-40
- Guide telescopiche e fisse
- Struttura senza fori = facile da pulire
- Alluminio anodizzato 20 micron = nessun difetto di verniciatura
- Inossidabile
- Leggero
- Capacita' di carico di 1000 kg per unità.
- Range termico: da -20°C a +80°C
- Flat packaging = risparmio sul trasporto
- Lunga durata nel tempo
- Montaggio senza attrezzi speciali
- Massimo sfruttamento dello spazio



SALUS SERIES



PANNELLO SUPERIORE

In alluminio, rimovibile per facilitare le operazioni di pulizia



GUIDE

Permettono di estrarre i cestelli verso il fronte in posizione orizzontale o inclinata



GUIDE DOPPIO ACCESSO

I cestelli possono essere estratti da entrambi i lati della scaffalatura o carrello

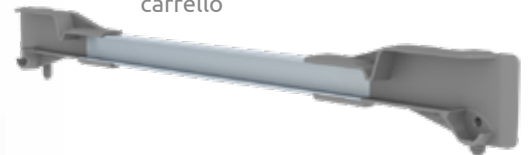

RUOTE AD INNESTO

Opzionali, per uno scorrimento più fluido, si innestano facilmente grazie alla predisposizione di serie

Non compatibile con il Blocco Anticaduta

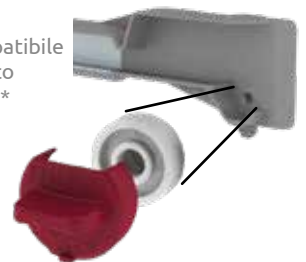

GUIDE TELESCOPICHE

Opzionali, consentono l'estrazione totale del vassoio

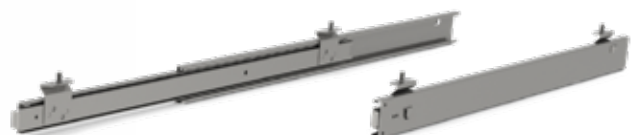

SOLUZIONI STATICHE - TIPO-E



SLS-RACK-E-1880

UNITÀ BASE TIPO-E
12 POSIZIONI
715x430x H1880 mm



SLS-RKAD-E-1880

UNITÀ ADDIZ.
BASE TIPO-E 12
POSIZIONI
680x430x H1880 mm



SLS-RAIL-E-1

GUIDE TIPO-E
(COPPIA) - 400 mm



SLS-RAIL-DS-E

GUIDA TIPO-E DOPPIO
ACCESSO (COPPIA) -
400 mm



SLS-TOP-E

TOP COVER
TIPO-E

SOLUZIONI STATICHE - TIPO-U



SLS-RACK-U-1880

UNITÀ BASE TIPO-U
12 POSIZIONI
515x630x H1880 mm



SLS-RKAD-U-1880

UNITÀ ADDIZ.
BASE TIPO-U
12 POSIZIONI
480x630x H1880 mm



SLS-RAIL-U-1

GUIDE TIPO-U
(COPPIA) - 600 mm

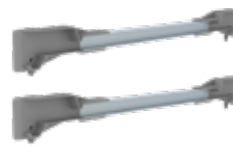

SLS-RAIL-DS-U

GUIDA TIPO-U DOPPIO
ACCESSO (COPPIA) -
600 mm



SLS-TOP-U

TOP COVER
TIPO U

OPTIONAL COMUNI



SLS-BBG-RK-E

GUIDA TELESCOPICA TIPO-E
(COPPIA) - 400 mm



SLS-BBG-RK-U

GUIDA TELESCOPICA TIPO-U
(COPPIA) - 600 mm



SLS-RAIL-4TLS

SERIE DI 4 PIASTRE PER
GUIDE TELESCOPICHE



PNWL-SET

RUOTINA DI
SCORRIMENTO (CAD.)

SCAFFALATURE MEDICALI

SALUS SERIES



Esempio di scaffalatura medica TIPO-U
1 unità base + 5 unità aggiuntive

DIMENSIONI SCAFFALATURA TIPO-E

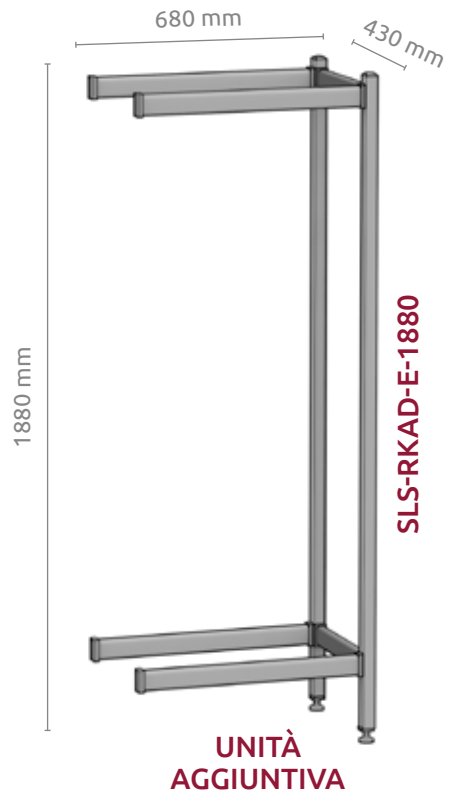
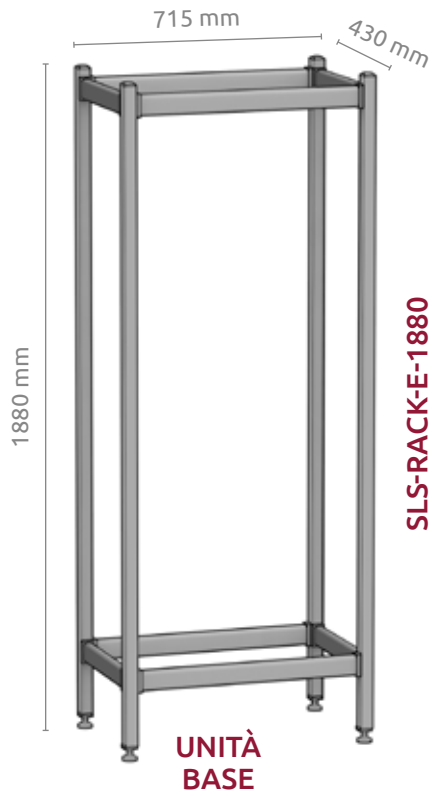

DIMENSIONI SCAFFALATURA TIPO-U

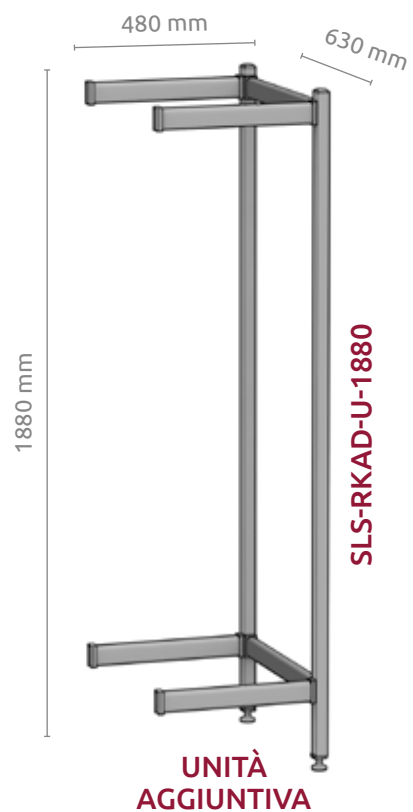
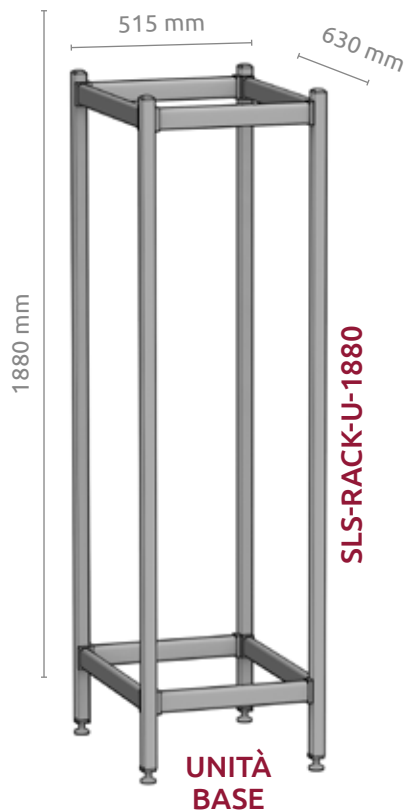

PORTATA PER SINGOLA CAMPATA - 1000 kg

SALUS SERIES

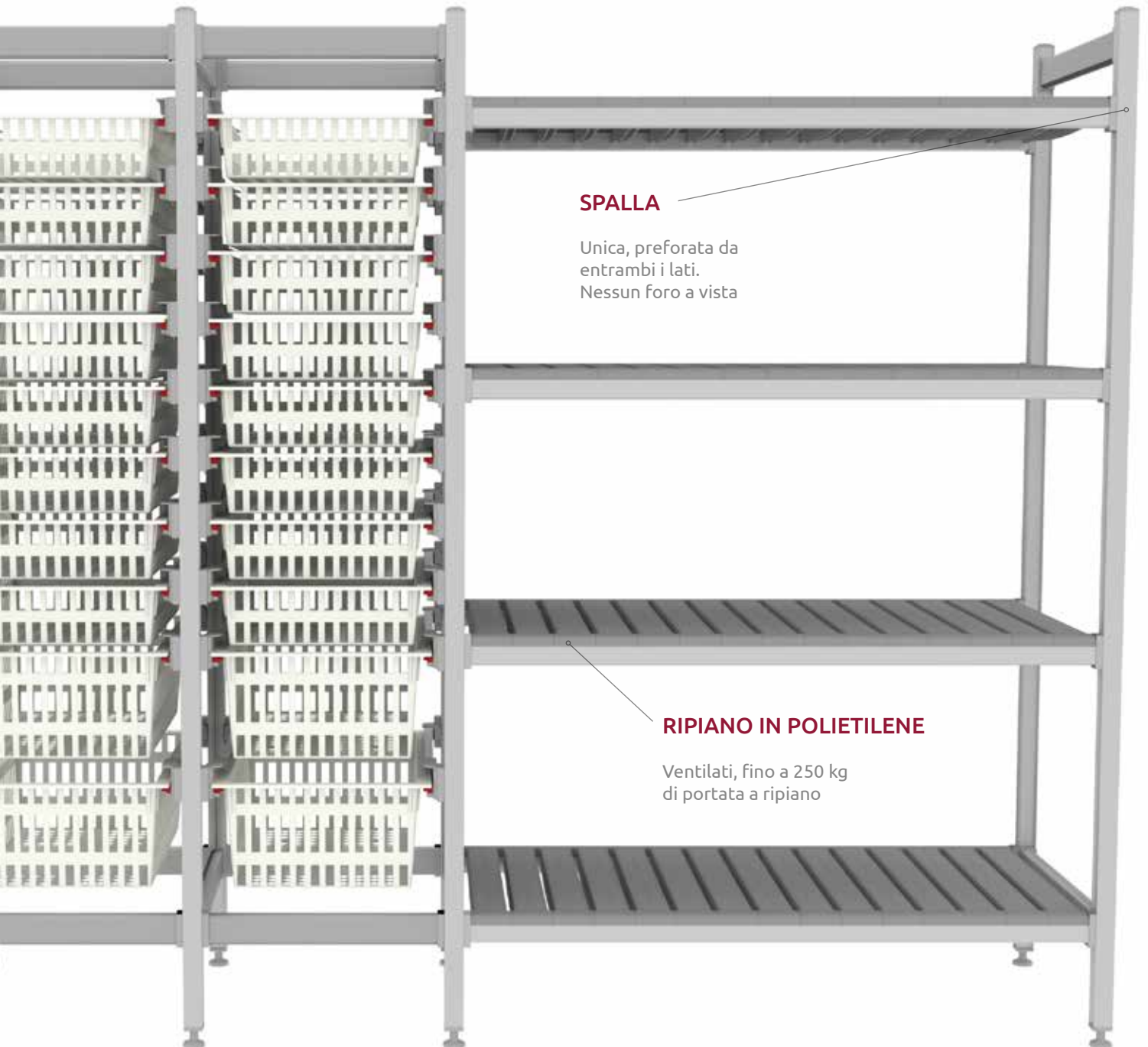

SPALLA

Unica, preforata da entrambi i lati.
Nessun foro a vista

RIPIANO IN POLIETILENE

Ventilati, fino a 250 kg
di portata a ripiano

Esempio di scaffalatura medica a ripiani SALUS Series
1 spalla + 4 ripiani in polietilene ad alta densità



Guarda il video

SPALLA IN ALLUMINIO

Altezza mm (H)	Portata kg (c.u.d.)	Profondità 450 (W) Art.	Profondità 600 (W) Art.
1880	1000	SLS-FRAC-E-1880	SLS-FRAC-U-1880

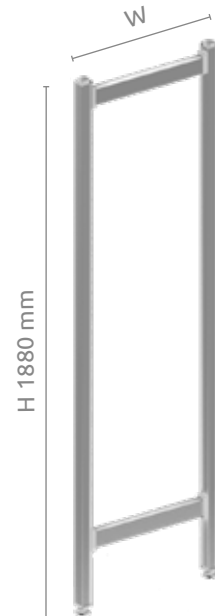

Completa di basi regolabili e tappi

Ripiano Ventilato - Doghe in polietilene o alluminio

Lunghezza mm (L)	Portata kg (c.u.d.)	Profondità 450 (W) Art.	Profondità 600 (W) Art.
400	250	SLS442	SLS592
475	250	SLS444	SLS594
550	250	SLS446	SLS596
625	250	SLS448	SLS598
700	250	SLS450	SLS600
775	250	SLS452	SLS602
850	250	SLS454	SLS604
925	240	SLS456	SLS606
1000	240	SLS458	SLS608
1075	220	SLS460	SLS610
1150	220	SLS462	SLS612
1225	220	SLS464	SLS614
1300	200	SLS466	SLS616
1375	200	SLS468	SLS618
1450	200	SLS470	SLS620
1525	180	SLS472	SLS622
1600	180	SLS474	SLS624
1675	180	SLS476	SLS626
1750	150	SLS478	SLS628
1825	150	SLS480	SLS630
1900	120	SLS482	SLS632
1975	110	SLS484	SLS634

DOGHE IN POLIETILENE GRIGIO CHIARO

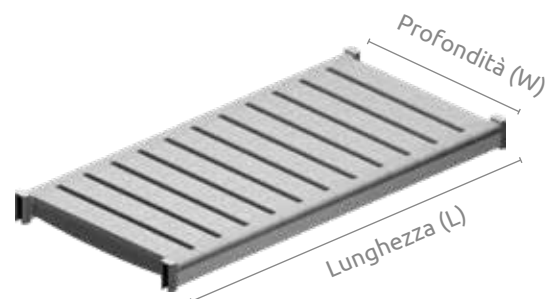

Completo di n°4 tasselli di aggancio alle spalle

CARRELLI MEDICALI DI TRASPORTO APERTI



SLS-UU-1880

Carrello TIPO-UU,
12 posizioni, due colonne



SLS-EE-1160

Carrello TIPO-EE,
6 posizioni, due colonne

SLS-ALPH-E

Maniglia orizzontale
per carrelli E



SLS-ALPH-VER

Maniglia verticale per carrelli



CARRELLI MEDICALI DI TRASPORTO APERTI



GUIDE

Permettono di estrarre i cestelli verso il fronte in posizione orizzontale o inclinata



GUIDE DOPPIO ACCESSO

I cestelli possono essere estratti da entrambi i lati della scaffalatura o carrello



MANIGLIE

Opzionali, per uno scorrimento più fluido

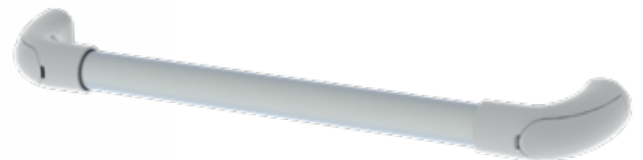

RUOTE AD INNESTO

Opzionali, per uno scorrimento più fluido, si innestano facilmente grazie alla predisposizione di serie

Non compatibile con il Blocco Anticaduta

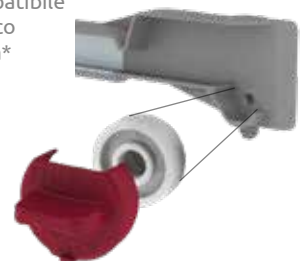

CARRELLI TIPO E

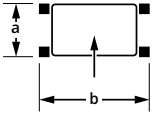
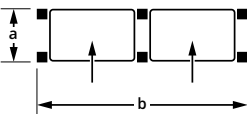
Disposizione	Tipo	N° Max guide	Altezza (H) mm	Dimensioni Carrello (mm)	Art.
	E	6	1130	(a) x (b) 770 x 485	SLS-E-1160
		8	1370		SLS-E-1400
		10	1640		SLS-E-1640
		12	1880		SLS-E-1880
	EE	12	1130	(a) x (b) 1450 x 485	SLS-EE-1160
		16	1370		SLS-EE-1400
		20	1640		SLS-EE-1640
		24	1880		SLS-EE-1880

CARRELLI TIPO U

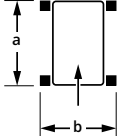
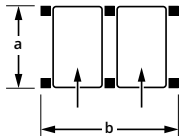
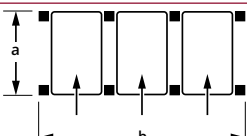
Disposizione	Tipo	N° Max guide	Altezza (H) mm	Dimensioni Carrello (mm)	Art.
	U	6	1130	(a) x (b) 685 x 570	SLS-U-1160
		8	1370		SLS-U-1400
		10	1640		SLS-U-1640
		12	1880		SLS-U-1880
	UU	12	1130	(a) x (b) 685 x 1050	SLS-UU-1160
		16	1370		SLS-UU-1400
		20	1640		SLS-UU-1640
		24	1880		SLS-UU-1880
	UUU	18	1130	(a) x (b) 685 x 1530	SLS-UUU-1160
		24	1370		SLS-UUU-1400

GUIDE TIPO E



SLS-RAIL-E-1

GUIDE TIPO-E
(COPPIA) - 400 mm



SLS-RAIL-DS-E

GUIDA TIPO-E DOPPIO
ACCESSO (COPPIA) - 400 mm



SLS-RAIL-U-1

GUIDE TIPO-U
(COPPIA) - 600 mm



SLS-RAIL-DS-U

GUIDA TIPO-U DOPPIO
ACCESSO (COPPIA) - 600 mm

OPTIONAL COMUNI



SLS-ALPH-E

MANIGLIA ORIZZONTALE
PER CARRELLI E

SLS-ALPH-U

MANIGLIA ORIZZONTALE
PER CARRELLI U

SLS-ALPH-VER

MANIGLIA VERTICALE
PER CARRELLI



PNWL-SET

RUOTINA DI
SCORRIMENTO (CAD.)

CARRELLI DI SERVIZIO

A Ripiani

Progettato per coniugare la leggerezza e la maneggevolezza con la robustezza. Con la sua struttura completamente in alluminio è dotato di 4 ruote con freno e paracolpi in resina. I ripiani, disponibili in polietilene o in alluminio, sono costituiti da doghe amovibili di facile e veloce pulizia.

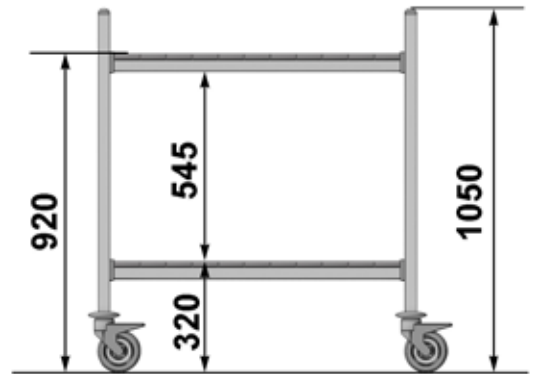

Portata
totale
125 kg

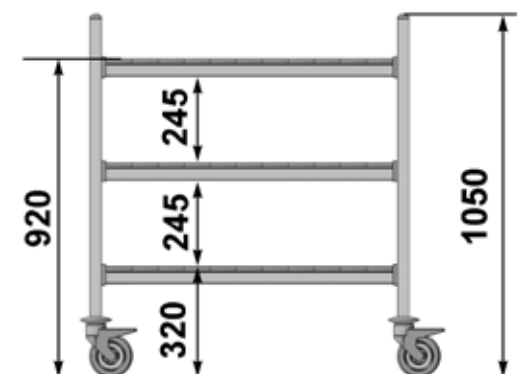

H = 1050 MM / PORTATA TOTALE 125 KG / N°2 RIPIANI

Art.	H	L1	W1	L2	W2
TP48D2	1050	625	450	725	480
TP48F2	1050	775	450	875	480
TP48H2	1050	925	450	1025	480
TP58H2	1050	925	525	1025	555
TP68H2	1050	925	600	1025	630
TP68L2	1050	1225	600	1325	630
TP68P2	1050	1525	600	1625	630



Completo di ruote con freno,
paracolpi optional

H = 1050 MM / PORTATA TOTALE 125 KG / N°3 RIPIANI

Art.	H	L1	W1	L2	W2
TP48D3	1050	625	450	725	480
TP48F3	1050	775	450	875	480
TP48H3	1050	925	450	1025	480
TP58H3	1050	925	525	1025	555
TP68H3	1050	925	600	1025	630
TP68L3	1050	1225	600	1325	630
TP68P3	1050	1525	600	1625	630



SPONDA ANTICADUTA LIGHT LONGITUDINALE

Lunghezza mm (L)	Art.
625	KFGT07
775	KFGT09
925	KFGT11
1225	KFGT15
1525	KFGT19



SPONDA ANTICADUTA PESANTE LONGITUDINALE

Lunghezza mm (L)	Art.
625	KFG007
775	KFG009
925	KFG011
1225	KFG015
1525	KFG019



PARACOLPI IN GOMMA Ø 95 MM

Art.	Descrizione
PCSCF5	Paracolpi in gomma ø 95 mm

* L'uso del paracolpi optional aumenta la quota l2 / w2 di 60 mm



MANIGLIA DI SPINTA

Art.	Descrizione
SLS-ALPH-450	Maniglia di spinta alluminio 450 mm
SLS-ALPH-525	Maniglia di spinta alluminio 525 mm
SLS-ALPH-600	Maniglia di spinta alluminio 600 mm



CENTRALI DI STERILIZZAZIONE (CSSD)

SALUS Series è un sistema completamente sigillato, non ci sono fori aperti in tutta la struttura, rendendo le superfici facilmente accessibili per la pulizia.

L'intero sistema è realizzato in alluminio anodizzato da 20 micron; niente più problemi di verniciatura.

Il sistema di etichettatura delle scaffalature medicali SALUS Series consente di rimuovere ripiani o contenitori mentre le relative etichette rimangono sulla struttura contrassegnando la posizione originale, i prodotti verranno sempre riportati nella stessa posizione.



SOLUZIONI STATICHE - TIPO-E



SLS-RACK-E-2000

UNITÀ BASE TIPO-E
13 POSIZIONI
715x430x H2000 mm



SLS-RKAD-E-2000

UNITÀ ADDIZ. TIPO-E
13 POSIZIONI
680x430x H2000 mm



SLS-RAIL-E-1

GUIDE TIPO-E
(COPPIA) - 400 mm



SLS-RAIL-DS-E

GUIDA TIPO-E DOPPIO
ACCESSO (COPPIA) -
400 mm



SLS-TOP-E

TOP COVER
TIPO-E

SOLUZIONI STATICHE - TIPO-U



SLS-RACK-U-2000

UNITÀ BASE TIPO-U
13 POSIZIONI
515x630x H2000 mm



SLS-RKAD-U-2000

UNITÀ ADDIZ. TIPO-U
13 POSIZIONI
480x630x H2000 mm



SLS-RAIL-U-1

GUIDE TIPO-U
(COPPIA) - 600 mm



SLS-RAIL-DS-U

GUIDA TIPO-U DOPPIO
ACCESSO (COPPIA) -
600 mm



SLS-TOP-U

TOP COVER
TIPO U

OPTIONAL COMUNI



SLS-BBG-RK-E

GUIDA TELESCOPICA TIPO-E
(COPPIA) - 400 mm



SLS-BBG-RK-U

GUIDA TELESCOPICA TIPO-U
(COPPIA) - 600 mm



SLS-RAIL-4TLS

SERIE DI 4 PIASTRE
PER GUIDE TELESCOPICHE



PNWL-SET

RUOTINA DI
SCORRIMENTO (CAD.)

PRODOTTI ISO 60-40 PER CSSD

NO Touch™

Dal centro di sterilizzazione alla sala operatoria, il sistema No-Touch™ elimina l'interazione umana durante il trasporto dello strumento grazie ai nostri ripiani e cestelli in acciaio inossidabile standard ISO dedicati e alle nostre linee funzionali di carrelli di trasporto aperti e chiusi.

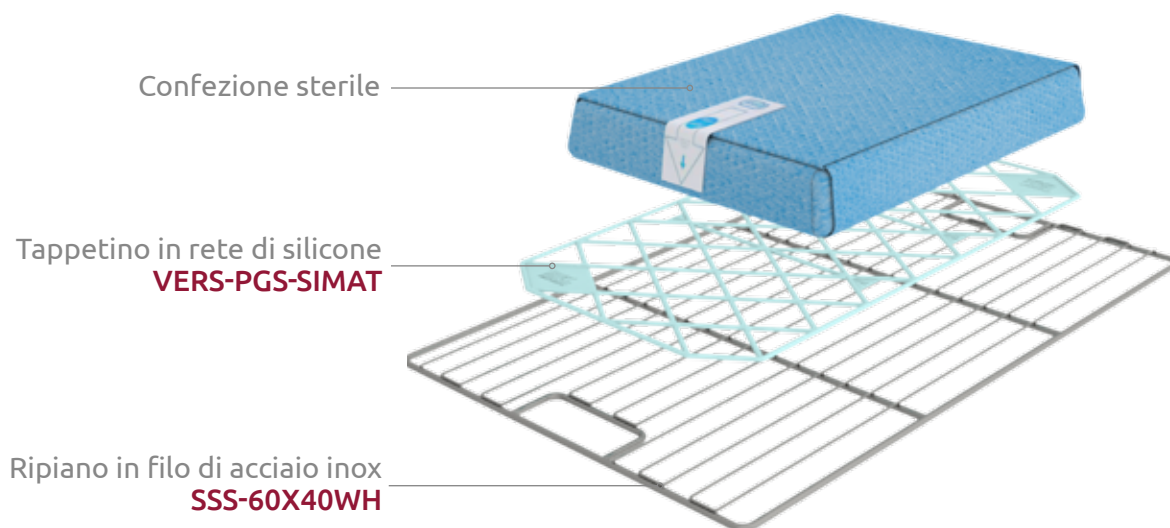

CONTENITORI IN FILO DI ACCIAIO INOX



WS-B104060-SS-WH

CESTELLO IN FILO DI ACCIAIO
INOX H10x60x40 mm



WS-B204060-SS-WH

CESTELLO IN FILO DI ACCIAIO
INOX H20x60x40 mm

RIPIANI IN FILO DI ACCIAIO INOX

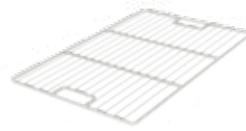

SSS-6040WH

RIPIANO IN FILO DI ACCIAIO
INOX 60x40



SSS-3040WH

RIPIANO IN FILO DI ACCIAIO
INOX 30x40

TAPPETINI ANTI SCIVOLO

È possibile personalizzare la dimensione della rete
utilizzando le forbici

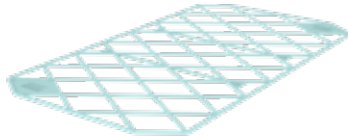
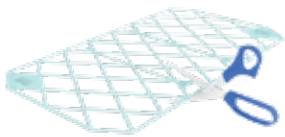

WS-INSTR-SS

4 DIMENSIONI IN UN UNICO PRODOTTO:
275 x 485mm | 275 x 305mm
275 x 185mm | 275 x 485mm

RIPIANI INOX

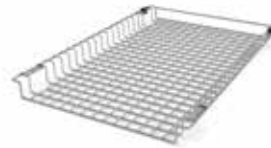

WS-INSTR-SS

RIPIANO INOX IN FILO PER
CONTENITORI STRUMENTI
MEDICALI



SS-U-CNT-SHELF

RIPIANO INOX PIENO PER
CONTENITORI

MANIGLIE PER RIPIANO INOX PIENO



HNDL-112MM-ALU

MANIGLIA IN ALLUMINIO
OPACO



HNDL-112MM-RED

MANIGLIA IN ALLUMINIO
ROSSA



HNDL-112MM-BLUE

MANIGLIA IN ALLUMINIO BLU



HNDL-112MM-YLW

MANIGLIA IN ALLUMINIO
GIALLA

SCAFFALATURA A RIPIANI

TOP SALUS



GRANDI PORTATE:
FINO A 250 KG PER RIPIANO



LEGGERO



FACILE DA PULIRE



MONTAGGIO RAPIDO



RANGE TERMICO:
DA -30°C A +90°C



FLAT PACKAGING = RISPARMIO SUL TRASPORTO



LUNGA DURATA NEL TEMPO



MONTAGGIO SENZA
ATTREZZI SPECIALI



ECOLOGICO SU TUTTA LA LINEA:
DALLA PRODUZIONE ALL'USO



MONTAGGIO FACILE DEI RIPIANI:
MASSIMA FLESSIBILITÀ E ROBUSTEZZA



USO ESCLUSIVO DI VITERIA IN
ACCIAIO INOX - NESSUNA VITE VISIBILE



CERTIFICAZIONI INTERNAZIONALI
DI IGIENE (HCV; NSF)



INOSSIDABILE - ALLUMINIO
ANODIZZATO 20 MICRON



MASSIMO SFRUTTAMENTO DELLO SPAZIO

DOGHE IN POLIETILENE GRIGIO CHIARO - DISTANZA TRA I RIPIANI MODIFICABILE



Lineare Singolo



Lineare Multiplo



Ad angolo



Ad "U"

SCAFFALATURA A RIPIANI

TOP SALUS

INNUMERAVOLI OPZIONI

Grazie alle molteplici differenti configurazioni standard, la nostra scaffalatura si adatta a qualsiasi tipo di deposito ospedaliero.

8 ALTEZZE

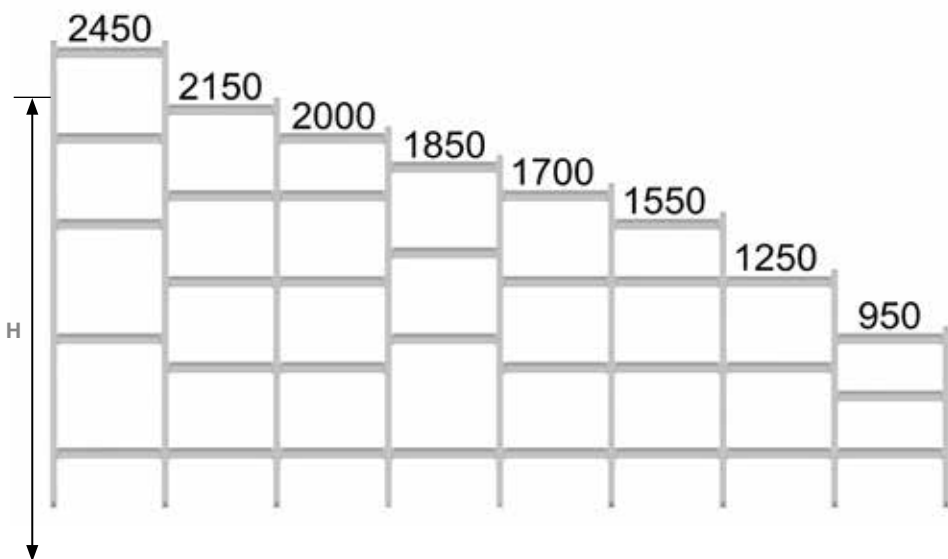

FACILITÀ DI PULIZIA

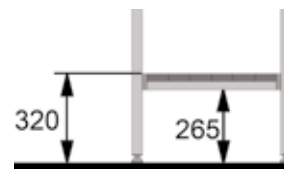

MODULARITÀ 75 MM



5 PROFONDITÀ (W), 22 LUNGHEZZE (L)

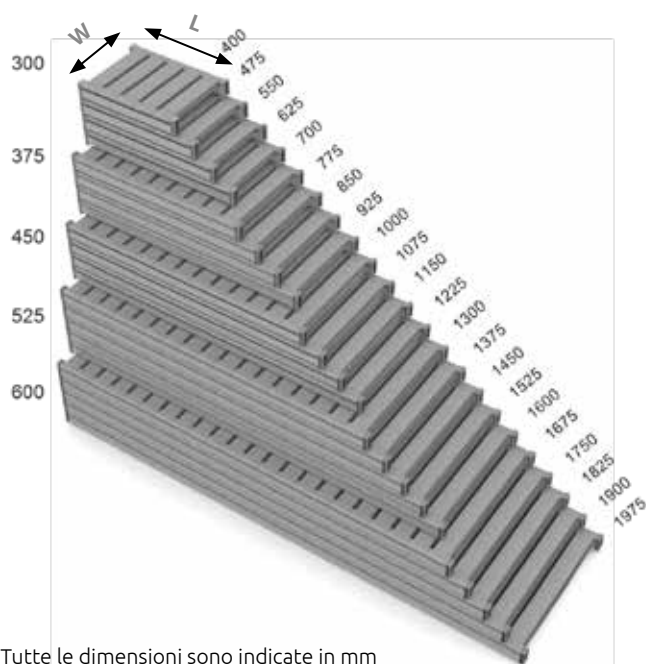

Tutte le dimensioni sono indicate in mm

DATI COMUNI A TUTTE LE PROFONDITÀ

(W = 300, 375, 450, 525, 600 mm)

Lunghezza ripiano mm (L)	Portata kg	Doghe n°	Lunghezza ripiano mm (L)	Portata kg	Doghe n°
400	250	5	1225	220	16
475	250	6	1300	200	17
550	250	7	1375	200	18
625	250	8	1450	200	19
700	250	9	1525	180	20
775	250	10	1600	180	21
850	250	11	1675	180	22
925	240	12	1750	150	23
1000	240	13	1825	150	24
1075	220	14	1900	120	25
1150	220	15	1975	110	26

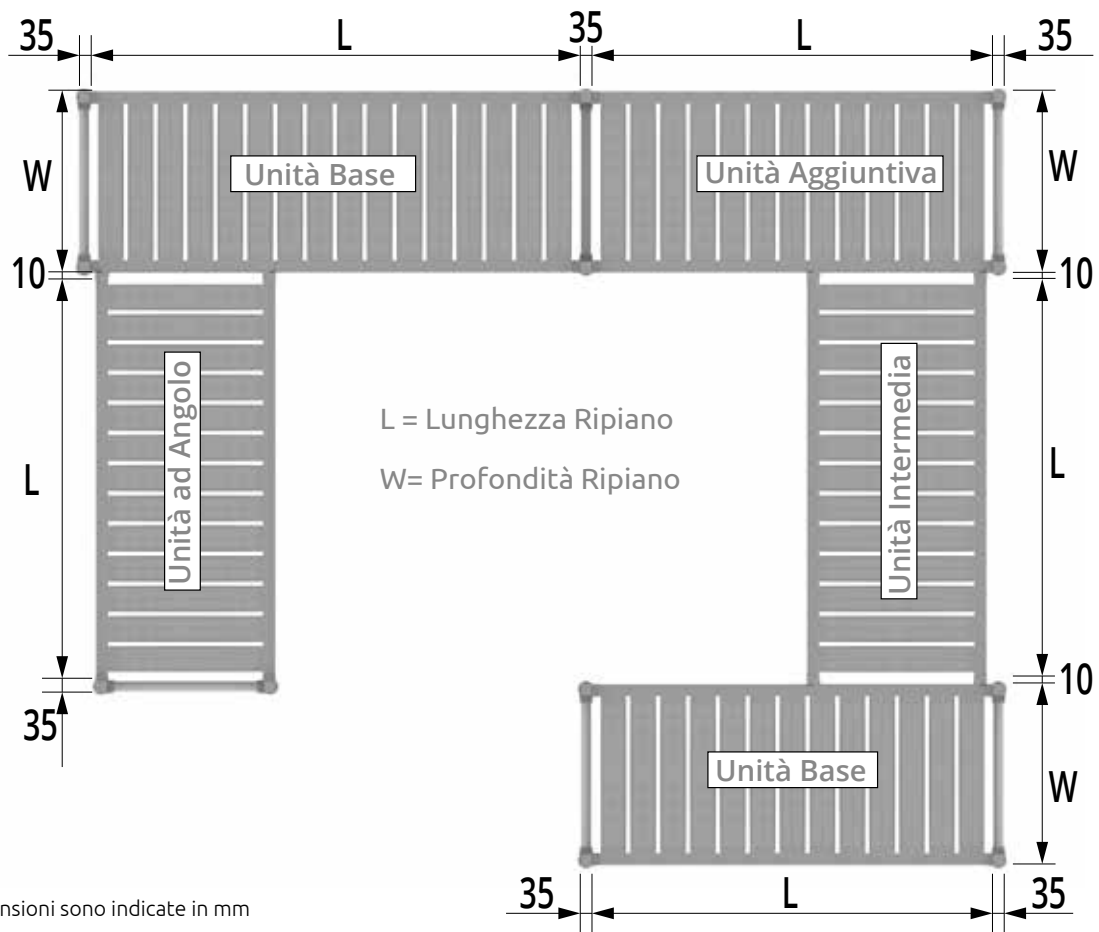
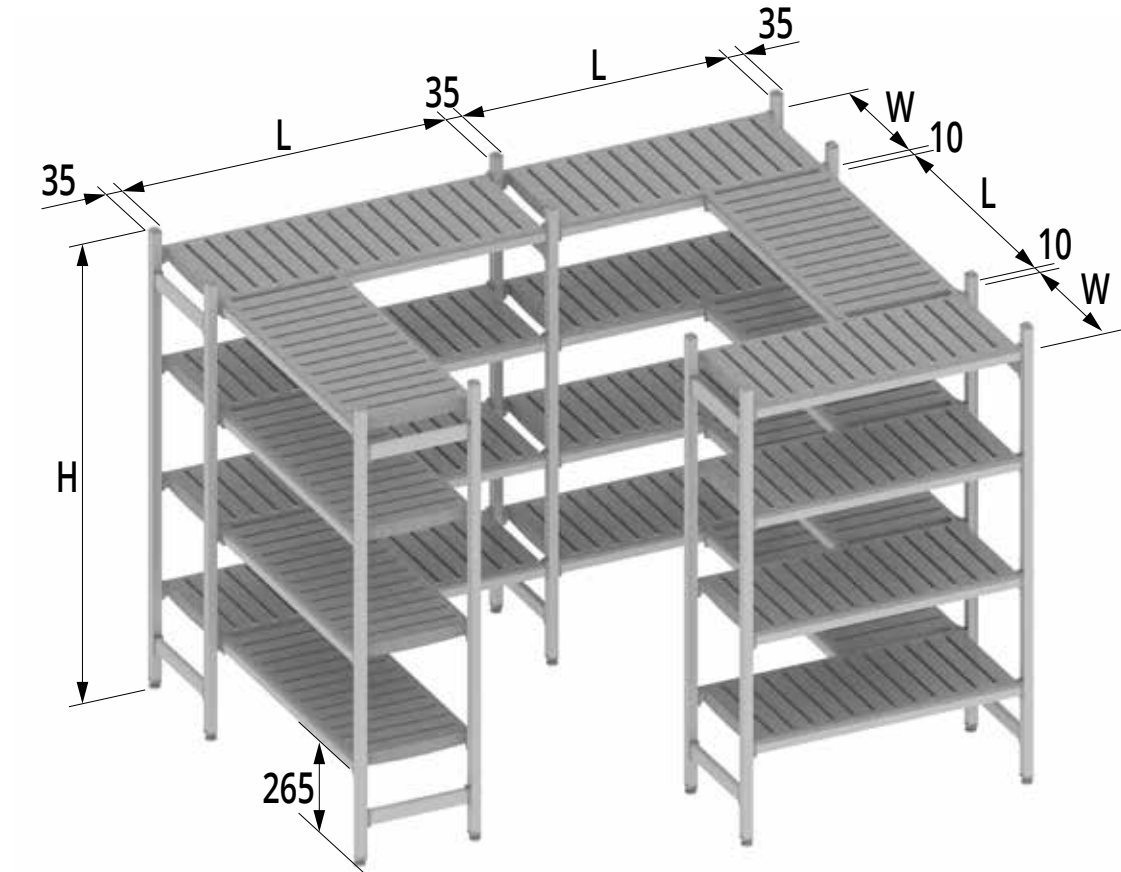

Tutte le dimensioni sono indicate in mm

SCAFFALATURA A RIPIANI

POSIZIONAMENTO SCAFFALI E CARRELLI

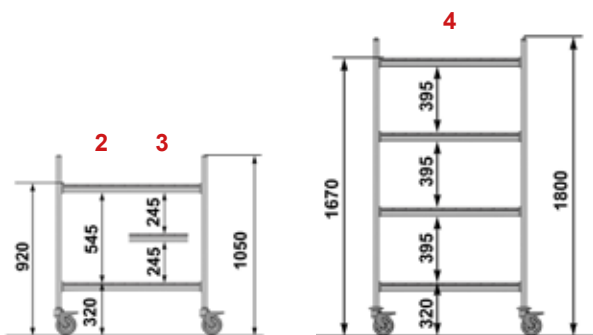

Carrelli standard

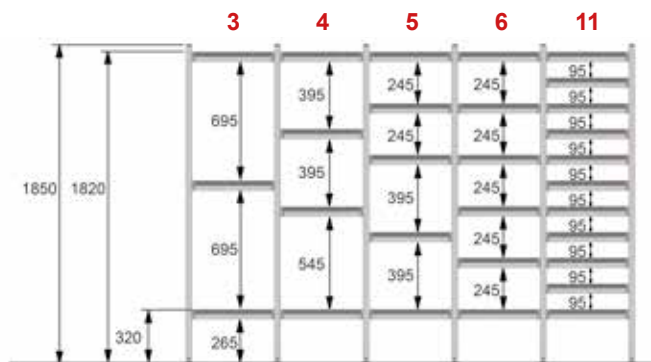

Altezza scaffale: 1850 mm / Altezza ambiente > 2100 mm

Nuovo

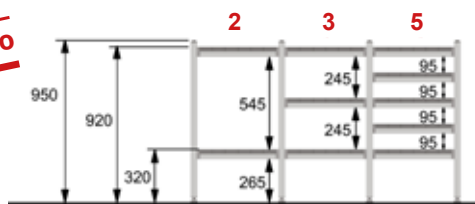

Altezza scaffale: 950 mm

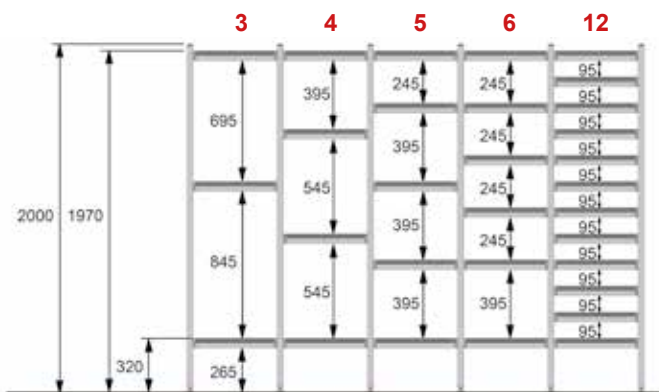

Altezza scaffale: 2000 mm / Altezza ambiente > 2250 mm

Nuovo



Altezza scaffale: 1250 mm

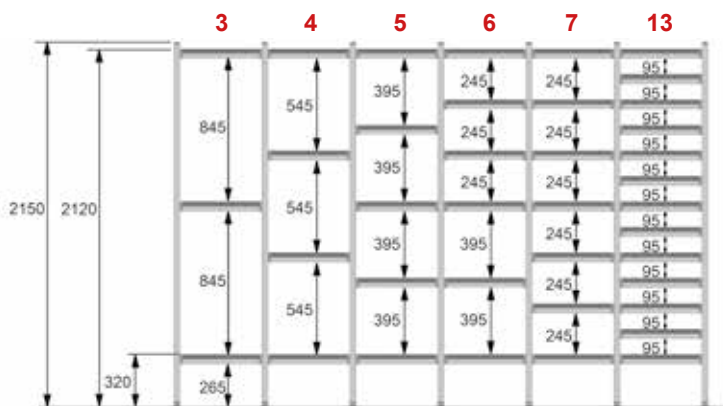

Altezza scaffale: 2150 mm / Altezza ambiente > 2400 mm

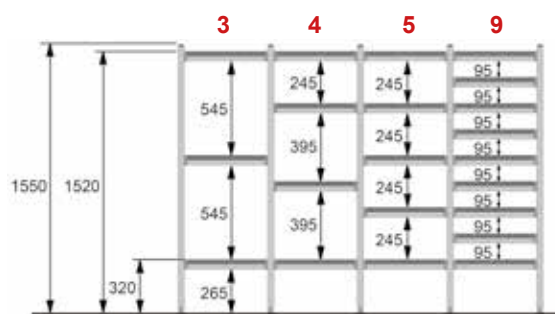

Altezza scaffale: 1550 mm / Altezza ambiente > 1700 mm



Altezza scaffale: 2450 mm / Altezza ambiente > 2800 mm

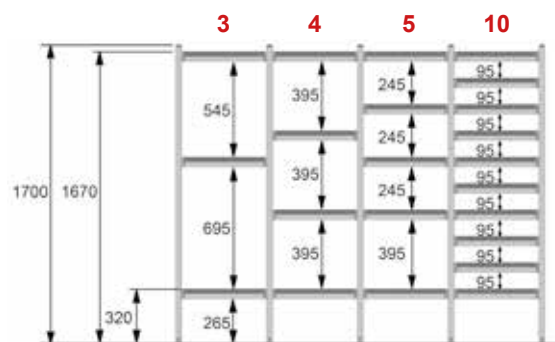

Altezza scaffale: 1700 mm / Altezza ambiente > 1950 mm

MONTAGGIO



**IL MONTAGGIO
DI UNA
SCAFFALATURA
RICHIEDE MENO DI
5 MINUTI**



**CON IL KIT ANGOLARE
SI AUMENTA
ED OTTIMIZZA
LA CAPACITÀ
DI STOCCAGGIO**



Video Montaggio

Durante l'installazione in cantiere della scaffalatura è consigliabile lasciare l'imballo in plastica. Così facendo proteggerete la scaffalatura fino a pochi istanti prima di inserire i prodotti in deposito.

SCAFFALATURA A RIPIANI

COMPONENTI SCAFFALATURA

SPALLA TERMINALE IN ALLUMINIO

Altezza mm (H)	Portata kg (c.u.d.)	Profondità 300 (W)	Profondità 375 (W)	Profondità 450 (W)	Profondità 525 (W)	Profondità 600 (W)
		Art.	Art.	Art.	Art.	Art.
950	1000	SLT290	SLT365	SLT440	SLT515	SLT590
1250	1000	SLT294	SLT369	SLT444	SLT519	SLT594
1550	1000	SLT298	SLT373	SLT448	SLT523	SLT598
1700	1000	SLT300	SLT375	SLT450	SLT525	SLT600
1850	1000	SLT301	SLT376	SLT451	SLT526	SLT601
2000	1000	SLT302	SLT377	SLT452	SLT527	SLT602
2150	1000	SLT303	SLT378	SLT453	SLT528	SLT603
2450	1000	SLT304	SLT379	SLT454	SLT529	SLT604

SPALLA CENTRALE IN ALLUMINIO

Altezza mm (H)	Portata kg (c.u.d.)	Profondità 300 (W)	Profondità 375 (W)	Profondità 450 (W)	Profondità 525 (W)	Profondità 600 (W)
		Art.	Art.	Art.	Art.	Art.
950	1000	SLC290	SLC365	SLC440	SLC515	SLC590
1250	1000	SLC294	SLC369	SLC444	SLC519	SLC594
1550	1000	SLC298	SLC373	SLC448	SLC523	SLC598
1700	1000	SLC300	SLC375	SLC450	SLC525	SLC600
1850	1000	SLC301	SLC376	SLC451	SLC526	SLC601
2000	1000	SLC302	SLC377	SLC452	SLC527	SLC602
2150	1000	SLC303	SLC378	SLC453	SLC528	SLC603
2450	1000	SLC304	SLC379	SLC454	SLC529	SLC604

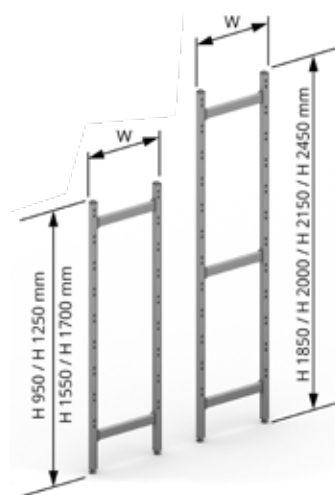

Completa di basi regolabili e tappi

RIPIANO IN ALLUMINIO CON DOGHE IN POLIETILENE

Lunghezza mm (L)	Portata kg (c.u.d.)	Profondità 300 (W)	Profondità 375 (W)	Profondità 450 (W)	Profondità 525 (W)	Profondità 600 (W)
		Art.	Art.	Art.	Art.	Art.
400	250	SLS292	SLS367	SLS442	SLS517	SLS592
475	250	SLS294	SLS369	SLS444	SLS519	SLS594
550	250	SLS296	SLS371	SLS446	SLS521	SLS596
625	250	SLS298	SLS373	SLS448	SLS523	SLS598
700	250	SLS300	SLS375	SLS450	SLS525	SLS600
775	250	SLS302	SLS377	SLS452	SLS527	SLS602
850	250	SLS304	SLS379	SLS454	SLS529	SLS604
925	240	SLS306	SLS381	SLS456	SLS531	SLS606
1000	240	SLS308	SLS383	SLS458	SLS533	SLS608
1075	220	SLS310	SLS385	SLS460	SLS535	SLS610
1150	220	SLS312	SLS387	SLS462	SLS537	SLS612
1225	220	SLS314	SLS389	SLS464	SLS539	SLS614
1300	200	SLS316	SLS391	SLS466	SLS541	SLS616
1375	200	SLS318	SLS393	SLS468	SLS543	SLS618
1450	200	SLS320	SLS395	SLS470	SLS545	SLS620
1525	180	SLS322	SLS397	SLS472	SLS547	SLS622
1600	180	SLS324	SLS399	SLS474	SLS549	SLS624
1675	180	SLS326	SLS401	SLS476	SLS551	SLS626
1750	150	SLS328	SLS403	SLS478	SLS553	SLS628
1825	150	SLS330	SLS405	SLS480	SLS555	SLS630
1900	120	SLS332	SLS407	SLS482	SLS557	SLS632
1975	110	SLS334	SLS409	SLS484	SLS559	SLS634

DOGHE IN POLIETILENE GRIGIO CHIARO

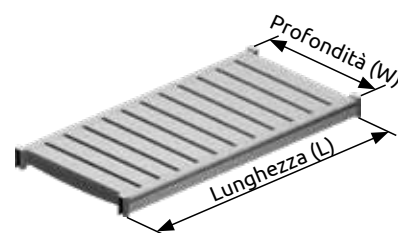

Completo di n°4 tasselli di aggancio alle spalle

KIT ANGOLARE CON DOGHE IN POLIETILENE

Tipo ripiano	Profondità 300 (W)	Profondità 375 (W)	Profondità 450 (W)	Profondità 525 (W)	Profondità 600 (W)
	Art.	Art.	Art.	Art.	Art.
Ventilato	SLA300	SLA375	SLA450	SLA525	SLA600



RIPIANO VENTILATO IN ALLUMINIO CON DOGHE IN ALLUMINIO

Lunghezza mm (L)	Portata kg (c.u.d.)	Profondità 300 (W) Art.	Profondità 375 (W) Art.	Profondità 450 (W) Art.	Profondità 525 (W) Art.	Profondità 600 (W) Art.
400	250	SLL292	SLL367	SLL442	SLL517	SLL592
475	250	SLL294	SLL369	SLL444	SLL519	SLL594
550	250	SLL296	SLL371	SLL446	SLL521	SLL596
625	250	SLL298	SLL373	SLL448	SLL523	SLL598
700	250	SLL300	SLL375	SLL450	SLL525	SLL600
775	250	SLL302	SLL377	SLL452	SLL527	SLL602
850	250	SLL304	SLL379	SLL454	SLL529	SLL604
925	240	SLL306	SLL381	SLL456	SLL531	SLL606
1000	240	SLL308	SLL383	SLL458	SLL533	SLL608
1075	220	SLL310	SLL385	SLL460	SLL535	SLL610
1150	220	SLL312	SLL387	SLL462	SLL537	SLL612
1225	220	SLL314	SLL389	SLL464	SLL539	SLL614
1300	200	SLL316	SLL391	SLL466	SLL541	SLL616
1375	200	SLL318	SLL393	SLL468	SLL543	SLL618
1450	200	SLL320	SLL395	SLL470	SLL545	SLL620
1525	180	SLL322	SLL397	SLL472	SLL547	SLL622
1600	180	SLL324	SLL399	SLL474	SLL549	SLL624
1675	180	SLL326	SLL401	SLL476	SLL551	SLL626
1750	150	SLL328	SLL403	SLL478	SLL553	SLL628
1825	150	SLL330	SLL405	SLL480	SLL555	SLL630
1900	120	SLL332	SLL407	SLL482	SLL557	SLL632
1975	110	SLL334	SLL409	SLL484	SLL559	SLL634

DOGHE IN ALLUMINIO PER RIPIANO VENTILATO

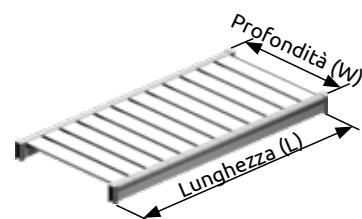

Completo di n°4 tasselli di aggancio alle spalle

RIPIANO PIENO IN ALLUMINIO CON DOGHE IN ALLUMINIO

Lunghezza mm (L)	Portata kg (c.u.d.)	Profondità 300 (W) Art.	Profondità 375 (W) Art.	Profondità 450 (W) Art.	Profondità 525 (W) Art.	Profondità 600 (W) Art.
400	250	SLP292	SLP367	SLP442	SLP517	SLP592
475	250	SLP294	SLP369	SLP444	SLP519	SLP594
550	250	SLP296	SLP371	SLP446	SLP521	SLP596
625	250	SLP298	SLP373	SLP448	SLP523	SLP598
700	250	SLP300	SLP375	SLP450	SLP525	SLP600
775	250	SLP302	SLP377	SLP452	SLP527	SLP602
850	250	SLP304	SLP379	SLP454	SLP529	SLP604
925	240	SLP306	SLP381	SLP456	SLP531	SLP606
1000	240	SLP308	SLP383	SLP458	SLP533	SLP608
1075	220	SLP310	SLP385	SLP460	SLP535	SLP610
1150	220	SLP312	SLP387	SLP462	SLP537	SLP612
1225	220	SLP314	SLP389	SLP464	SLP539	SLP614
1300	200	SLP316	SLP391	SLP466	SLP541	SLP616
1375	200	SLP318	SLP393	SLP468	SLP543	SLP618
1450	200	SLP320	SLP395	SLP470	SLP545	SLP620
1525	180	SLP322	SLP397	SLP472	SLP547	SLP622
1600	180	SLP324	SLP399	SLP474	SLP549	SLP624
1675	180	SLP326	SLP401	SLP476	SLP551	SLP626
1750	150	SLP328	SLP403	SLP478	SLP553	SLP628
1825	150	SLP330	SLP405	SLP480	SLP555	SLP630
1900	120	SLP332	SLP407	SLP482	SLP557	SLP632
1975	110	SLP334	SLP409	SLP484	SLP559	SLP634

DOGHE IN ALLUMINIO PER RIPIANO PIENO

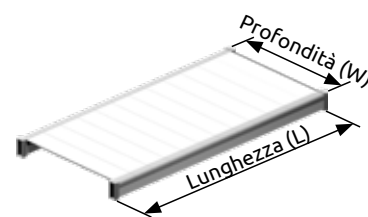

Completo di n°4 tasselli di aggancio alle spalle

KIT ANGOLARE CON DOGHE IN ALLUMINIO

Tipo ripiano	Profondità 300 (W) Art.	Profondità 375 (W) Art.	Profondità 450 (W) Art.	Profondità 525 (W) Art.	Profondità 600 (W) Art.
Ventilato	SLLA30	SLLA37	SLLA45	SLLA52	SLLA60
Pieno	SLPA30	SLPA37	SLPA45	SLPA52	SLPA60

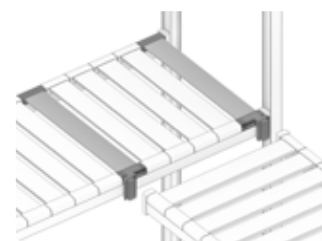

SCAFFALATURA A RIPIANI

SCAFFALATURA COMPATTABILE

La scaffalatura compattabile consente uno sfruttamento migliore dello spazio aumentando la capacità di stoccaggio rispetto ad una normale scaffalatura fissa.

Costruita in profilati di alluminio anodizzati 20 micron, la scaffalatura è interamente inossidabile ed ideale per depositi ospedalieri.

Le doghe dei ripiani sono smontabili e lavabili in lavastoviglie. Sviluppabile all'infinito in larghezza e lunghezza.

Le doghe possono essere in polietilene o in alluminio. Il polietilene è atossico, resistente agli agenti chimici e a basso assorbimento igroscopico. Tutta la bulloneria è in acciaio inox ed è nascosta all'interno della struttura stessa.

Resistente all'usura nel tempo ed insensibile agli sbalzi termici. L'assemblaggio ad incastro non richiede l'utilizzo di alcun utensile.

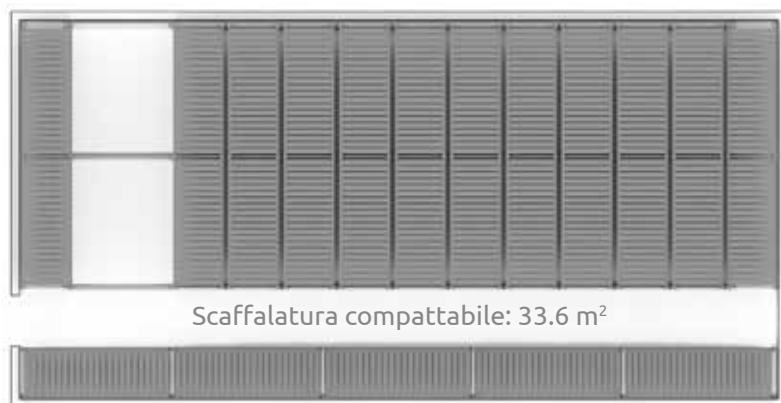
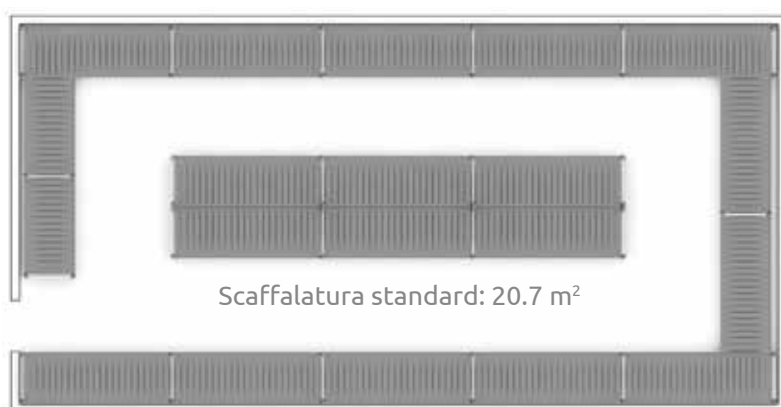

Struttura di stoccaggio
arredata con unità
statiche

**Soluz.
statica**
vs
**Soluz.
mobile**

Locale: 4,5 x 9 m = 40.5 m²

**Almeno il
60%**
di capacità di
stoccaggio in più

Struttura di stoccaggio
arredata con unità mobili



SCAFFALATURA A RIPIANI

SCAFFALATURA COMPATTABILE - GUIDA INFERIORE

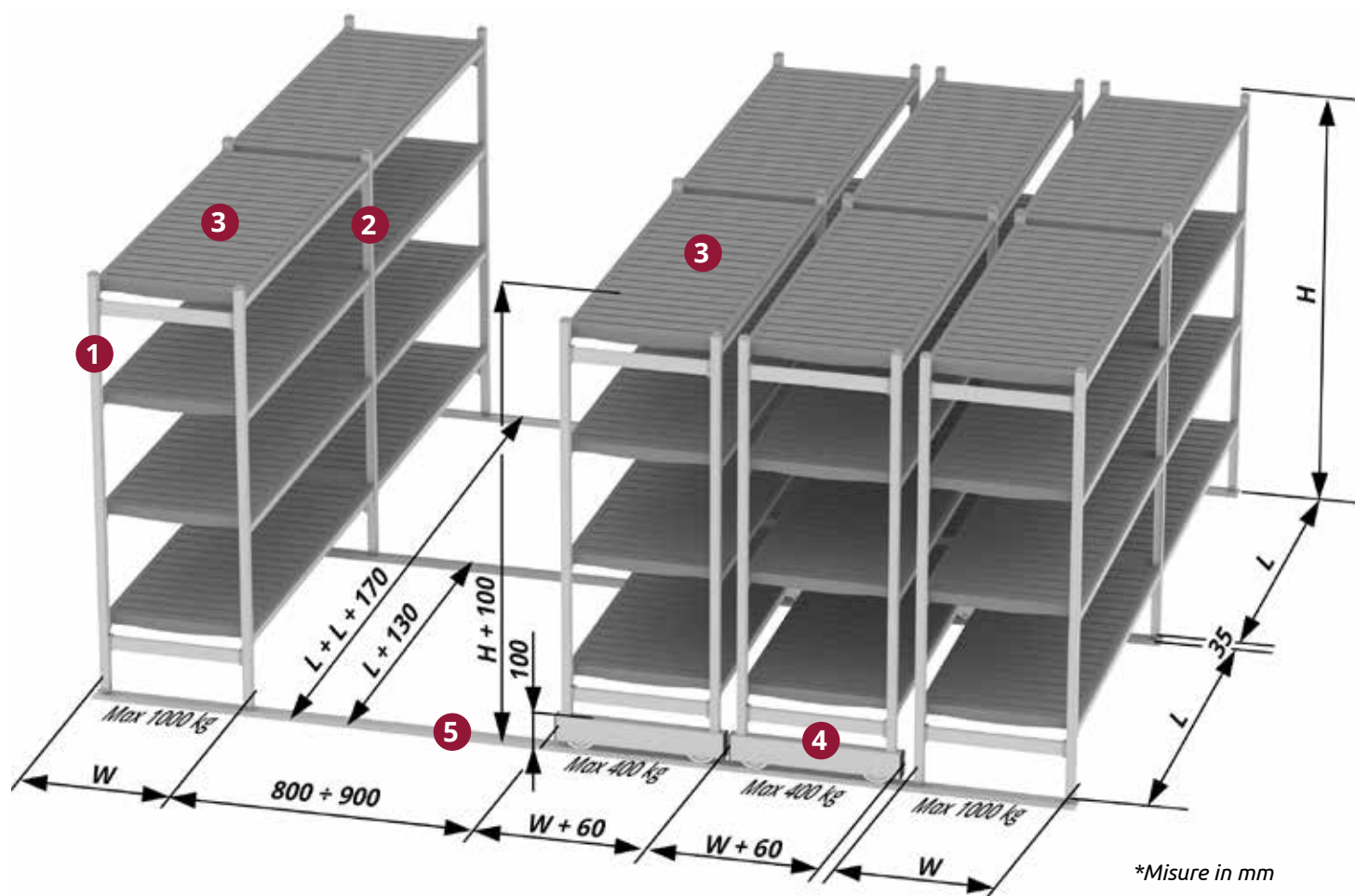

- 1 Spalla terminale
- 2 Spalla centrale
- 3 Ripiano ventilato
- 4 Basamento scorrevole inox
- 5 Guida inferiore

SPALLA TERMINALE IN ALLUMINIO

Pos.	Altezza mm (H)	Profondità mm (W)				
		300	375	450	525	600
1	1550	SLT298	SLT373	SLT448	SLT523	SLT598
	1700	SLT300	SLT375	SLT450	SLT525	SLT600
	1850	SLT301	SLT376	SLT451	SLT526	SLT601
	2000	SLT302	SLT377	SLT452	SLT527	SLT602
	2150	SLT303	SLT378	SLT453	SLT528	SLT603

SPALLA CENTRALE IN ALLUMINIO

Pos.	Altezza mm (H)	Profondità mm (W)				
		300	375	450	525	600
2	1550	SLC298	SLC373	SLC448	SLC523	SLC598
	1700	SLC300	SLC375	SLC450	SLC525	SLC600
	1850	SLC301	SLC376	SLC451	SLC526	SLC601
	2000	SLC302	SLC377	SLC452	SLC527	SLC602
	2150	SLC303	SLC378	SLC453	SLC528	SLC603

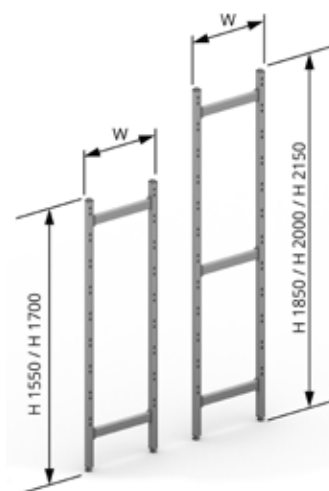

Completa di basi regolabili e tappi

RIPIANO CON DOGHE IN POLIETILENE (SPALLA FISSA)

Pos.	Lunghezza mm (L)	Profondità mm (W)				
		300	375	450	525	600
3	700	SLS300	SLS375	SLS450	SLS525	SLS600
	775	SLS302	SLS377	SLS452	SLS527	SLS602
	850	SLS304	SLS379	SLS454	SLS529	SLS604
	925	SLS306	SLS381	SLS456	SLS531	SLS606
	1000	SLS308	SLS383	SLS458	SLS533	SLS608
	1075	SLS310	SLS385	SLS460	SLS535	SLS610
	1150	SLS312	SLS387	SLS462	SLS537	SLS612
	1225	SLS314	SLS389	SLS464	SLS539	SLS614
	1300	SLS316	SLS391	SLS466	SLS541	SLS616
	1375	SLS318	SLS393	SLS468	SLS543	SLS618
	1450	SLS320	SLS395	SLS470	SLS545	SLS620
	1525	SLS322	SLS397	SLS472	SLS547	SLS622

DOGHE IN POLIETILENE GRIGIO CHIARO

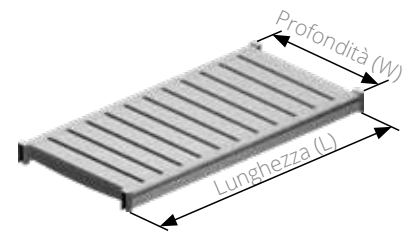

Completo di n°4 tasselli di aggancio alle spalle

Per altri tipi di ripiano fare riferimento alle tabelle a pagina 65.

RIPIANO CON DOGHE IN POLIETILENE (SPALLA MOBILE)

Pos.	Lunghezza mm (L)	Profondità mm (W)				
		300	375	450	525	600
3	700			SLS450	SLS525	SLS600
	775			SLS452	SLS527	SLS602
	850			SLS454	SLS529	SLS604
	925			SLS456	SLS531	SLS606
	1000			SLS458	SLS533	SLS608
	1075	NON FORNIBILE CON SPALLA MOBILE	NON FORNIBILE CON SPALLA MOBILE	SLS460	SLS535	SLS610
	1150			SLS462	SLS537	SLS612
	1225			SLS464	SLS539	SLS614
	1300			SLS466	SLS541	SLS616
	1375			SLS468	SLS543	SLS618
	1450			SLS470	SLS545	SLS620
	1525			SLS472	SLS547	SLS622

DOGHE IN POLIETILENE GRIGIO CHIARO

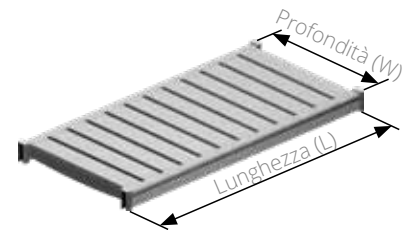

Completo di n°4 tasselli di aggancio alle spalle

Per altri tipi di ripiano fare riferimento alle tabelle a pagina 65.

BASAMENTO SCORREVOLE INOX

Pos.	Art.	Descrizione
4	BS45HD	Basamento scorrevole inox profondità 450 mm
	BS52HD	Basamento scorrevole inox profondità 525 mm
	BS60HD	Basamento scorrevole inox profondità 600 mm



GUIDA INFERIORE IN ALLUMINIO

Pos.	Art.	Descrizione
5	SGP8HD	2 barre guida 8 m (4 + 4)
	SGPMHD	Guida su misura



FISSAGGIO AGGIUNTIVO GUIDA A PAVIMENTO

Nel caso in cui si volesse fissare ulteriormente la guida a pavimento, si può richiedere la coppia tasselli cod. 2AGPHD



SCAFFALATURA A RIPIANI

SCAFFALATURA COMPATTABILE - GUIDA SUPERIORE

La scaffalatura compattabile con guida superiore è il prodotto perfetto per chi non vuole impedimenti a terra. Come la scaffalatura modulare è completamente personalizzabile in lunghezza, profondità e altezza. La scaffalatura compattabile con guida superiore è molto apprezzata anche per la sua incredibile robustezza e per la grande capacità di carico.

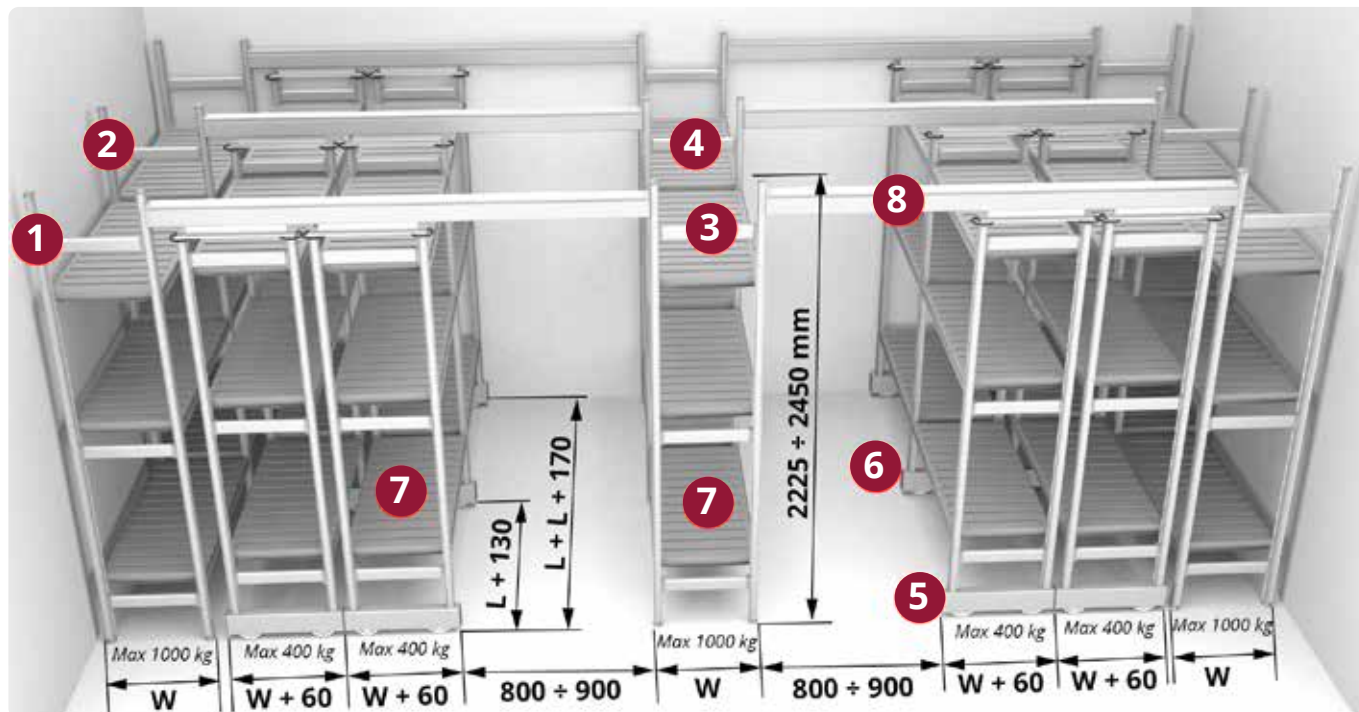

- 1** Spalla fissa terminale
- 2** Spalla fissa centrale
- 3** Spalla fissa terminale intermedia
- 4** Spalla fissa centrale intermedia
- 5** Spalla mobile terminale
- 6** Spalla mobile centrale
- 7** Ripiano ventilato
- 8** Guida superiore



Video Montaggio

SPALLE FISSE COMPATTABILE CON GUIDA SUPERIORE

Pos.	Art.	Descrizione	
1	SFT300	Spalla fissa terminale	H 2450 - W 300 mm
	SFT375	Spalla fissa terminale	H 2450 - W 375 mm
	SFT450	Spalla fissa terminale	H 2450 - W 450 mm
	SFT525	Spalla fissa terminale	H 2450 - W 525 mm
	SFT600	Spalla fissa terminale	H 2450 - W 600 mm
2	SFC300	Spalla fissa centrale	H 2450 - W 300 mm
	SFC375	Spalla fissa centrale	H 2450 - W 375 mm
	SFC450	Spalla fissa centrale	H 2450 - W 450 mm
	SFC525	Spalla fissa centrale	H 2450 - W 525 mm
	SFC600	Spalla fissa centrale	H 2450 - W 600 mm
3	SFTI30	Spalla fissa terminale intermedia	H 2450 - W 300 mm
	SFTI37	Spalla fissa terminale intermedia	H 2450 - W 375 mm
	SFTI45	Spalla fissa terminale intermedia	H 2450 - W 450 mm
	SFTI52	Spalla fissa terminale intermedia	H 2450 - W 525 mm
	SFTI60	Spalla fissa terminale intermedia	H 2450 - W 600 mm
4	SFCI30	Spalla fissa centrale intermedia	H 2450 - W 300 mm
	SFCI37	Spalla fissa centrale intermedia	H 2450 - W 375 mm
	SFCI45	Spalla fissa centrale intermedia	H 2450 - W 450 mm
	SFCI52	Spalla fissa centrale intermedia	H 2450 - W 525 mm
	SFCI60	Spalla fissa centrale intermedia	H 2450 - W 600 mm

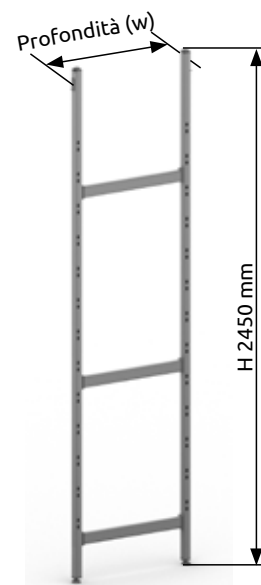

Misure speciali disponibili su richiesta

SPALLE MOBILI COMPATTABILE CON GUIDA SUPERIORE

Pos.	Art.	Descrizione	
5	SMT450	Spalla mobile terminale	H 2000 - W 450 mm
	SMT525	Spalla mobile terminale	H 2000 - W 525 mm
	SMT600	Spalla mobile terminale	H 2000 - W 600 mm
6	SMC450	Spalla mobile centrale	H 2000 - W 450 mm
	SMC525	Spalla mobile centrale	H 2000 - W 525 mm
	SMC600	Spalla mobile centrale	H 2000 - W 600 mm

Misure speciali disponibili su richiesta

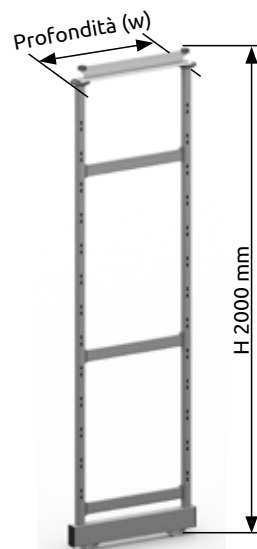

RIPIANO CON DOGHE IN POLIETILENE

Pos.	Lunghezza mm (L)	Solo per unità fissa		Per unità fissa e mobile		
		Profondità mm (W)		Profondità mm (W)		
		300	375	450	525	600
7	700	SLS300	SLS375	SLS450	SLS525	SLS600
	775	SLS302	SLS377	SLS452	SLS527	SLS602
	850	SLS304	SLS379	SLS454	SLS529	SLS604
	925	SLS306	SLS381	SLS456	SLS531	SLS606
	1000	SLS308	SLS383	SLS458	SLS533	SLS608
	1075	SLS310	SLS385	SLS460	SLS535	SLS610
	1150	SLS312	SLS387	SLS462	SLS537	SLS612
	1225	SLS314	SLS389	SLS464	SLS539	SLS614
	1300	SLS316	SLS391	SLS466	SLS541	SLS616
	1375	SLS318	SLS393	SLS468	SLS543	SLS618
	1450	SLS320	SLS395	SLS470	SLS545	SLS620
	1525	SLS322	SLS397	SLS472	SLS547	SLS622

Per altri tipi di ripiano fare riferimento alle tabelle a pagina 65.

DOGHE IN POLIETILENE GRIGIO CHIARO

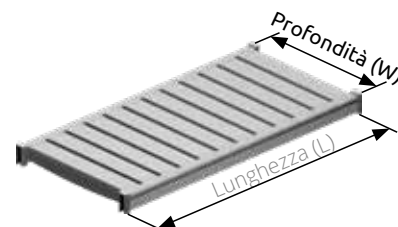

Completo di n°4 tasselli di aggancio alle spalle

GUIDA SUPERIORE

Pos.	Art.	Descrizione
8	S90MCP	Guida superiore alluminio H 90 mm su misura



SCAFFALATURA A RIPIANI

ANTIBATTERICA



PROTEZIONE CONTINUA PER L'INTERA VITA UTILE DELLA SCAFFALATURA.



CERTIFICAZIONI INTERNAZIONALI DI IGIENE



PORTATA FINO A 250 KG PER RIPIANO



ELIMINA +99% DEI BATTERI IN 24 ORE



LEGGERO



FACILE DA PULIRE



DIFESA IMPENETRABILE CONTRO: MICROBI, BATTERI, FUNGHI E MUFFE

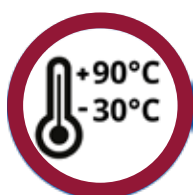

TEMPERATURE DA -30°C A +90°C



MONTAGGIO RAPIDO SENZA ATTREZZI SPECIALI



ALLUMINIO ANODIZZATO



ECOLOGICO DALLA PRODUZIONE ALL'USO



FLAT PACKAGING = RISPARMIO SUL TRASPORTO



SPALLA TERMINALE

Altezza mm (H)	Portata kg (c.u.d)	Profondità 450 (W) Art.	Profondità 600 (W) Art.
950	1000	SLT440	SLT590
1250	1000	SLT444	SLT594
1550	1000	SLT448	SLT598
1700	1000	SLT450	SLT600
1850	1000	SLT451	SLT601
2000	1000	SLT452	SLT602
2150	1000	SLT453	SLT603
2450	1000	SLT454	SLT604

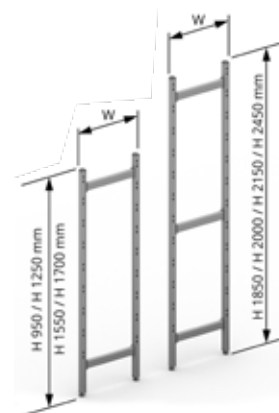

Completa di basi regolabili e tappi

SPALLA CENTRALE

Altezza mm (H)	Portata kg (c.u.d)	Profondità 450 (W) Art.	Profondità 600 (W) Art.
950	1000	SLC440	SLC590
1250	1000	SLC444	SLC594
1550	1000	SLC448	SLC598
1700	1000	SLC450	SLC600
1850	1000	SLC451	SLC601
2000	1000	SLC452	SLC602
2150	1000	SLC453	SLC603
2450	1000	SLC454	SLC604

RIPIANO DOGHE POLIETILENE TURCHESE

Lunghezza mm (L)	Portata kg (c.u.d)	Profondità 450 (W)	Profondità 600 (W)
		P/N	P/N
400	250	SLS442-AM	SLS592-AM
475	250	SLS444-AM	SLS594-AM
550	250	SLS446-AM	SLS596-AM
625	250	SLS448-AM	SLS598-AM
700	250	SLS450-AM	SLS600-AM
775	250	SLS452-AM	SLS602-AM
850	250	SLS454-AM	SLS604-AM
925	240	SLS456-AM	SLS606-AM
1000	240	SLS458-AM	SLS608-AM
1075	220	SLS460-AM	SLS610-AM
1150	220	SLS462-AM	SLS612-AM
1225	220	SLS464-AM	SLS614-AM
1300	200	SLS466-AM	SLS616-AM
1375	200	SLS468-AM	SLS618-AM
1450	200	SLS470-AM	SLS620-AM
1525	180	SLS472-AM	SLS622-AM
1600	180	SLS474-AM	SLS624-AM
1675	180	SLS476-AM	SLS626-AM
1750	150	SLS478-AM	SLS628-AM
1825	150	SLS480-AM	SLS630-AM
1900	120	SLS482-AM	SLS632-AM
1975	110	SLS484-AM	SLS634-AM



DOGHE IN POLIETILENE TURCHESE

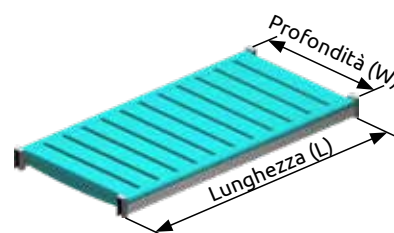

Completi di n°4 tasselli di aggancio alle spalle